

*New Era Public School*

*Solved assignment of Unit 1st*

*Class: L.K.G*

*Subject: Maths*

*Session: 2020-2021*

*Qno.1: Write in figures from 1-25*

*1 2 3 4 5 6 7 8 9 10*

*11 12 13 14 15 16 17 18 19 20*

*21 22 23 24 25*

*Qno.2: Backward counting from 10-1*

*10 9 8 7 6*

*5 4 3 2 1*

*Qno.3: Oral reading of numbers 1-25.*

*2no.4: Missing numbers.*

1   2        3   4        5   6        7   8  

9  10       11  12       13  14       15  16 

2.no.5: *Match the following numbers.*

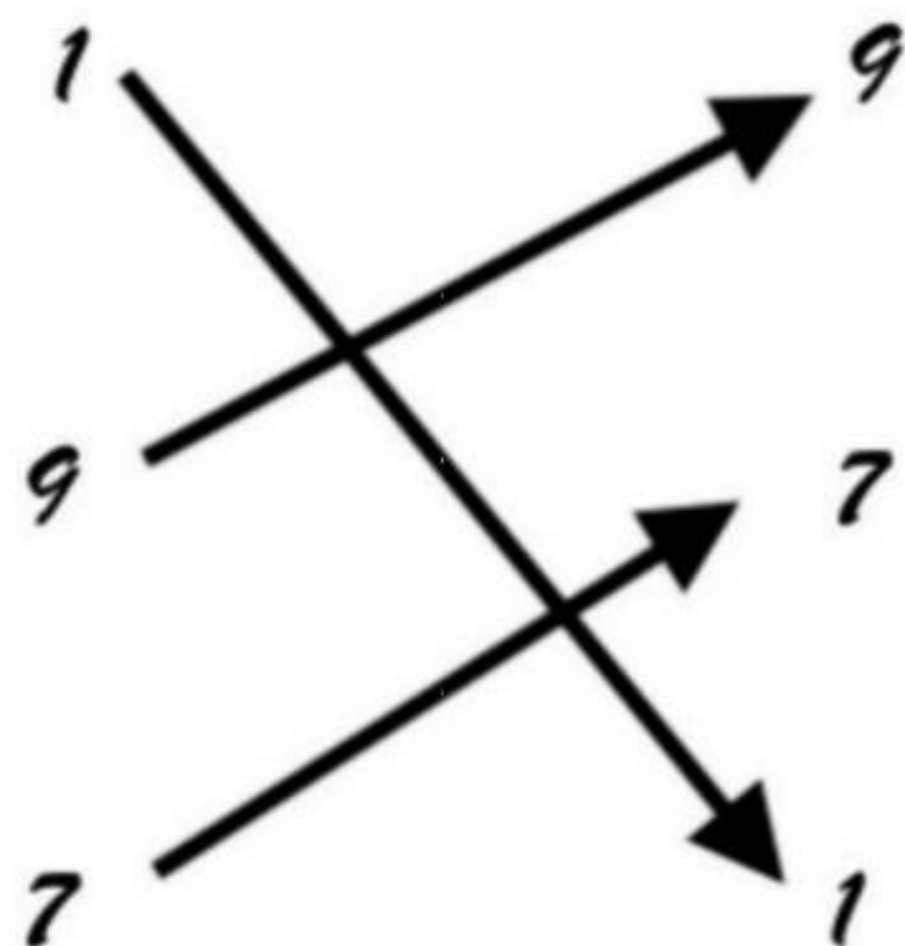
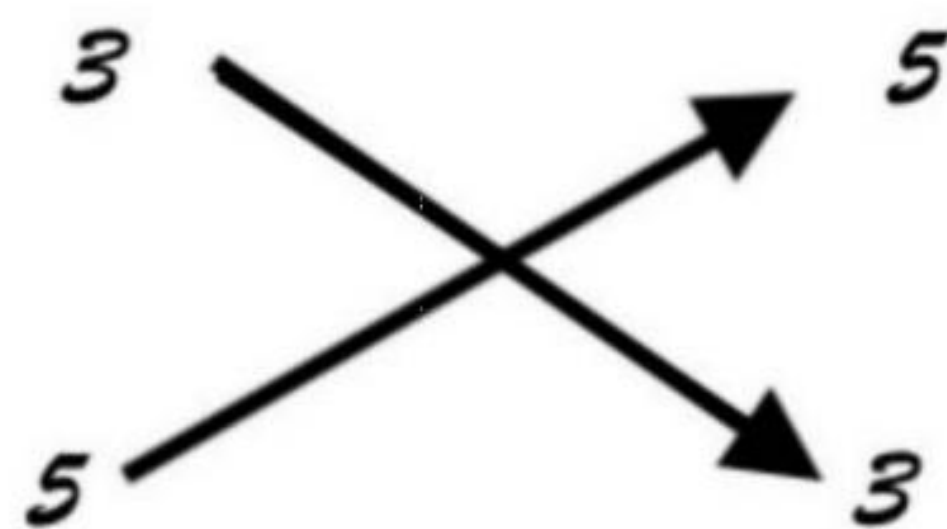

2. no. 6: Page writing

4                      5                      6                      7

---

---

---

---

---

---

---

2. no. 7 Page writing:

13                      14                      15                      16

---

---

---

---

---

---

---

# Practice Time

Draw standing lines:

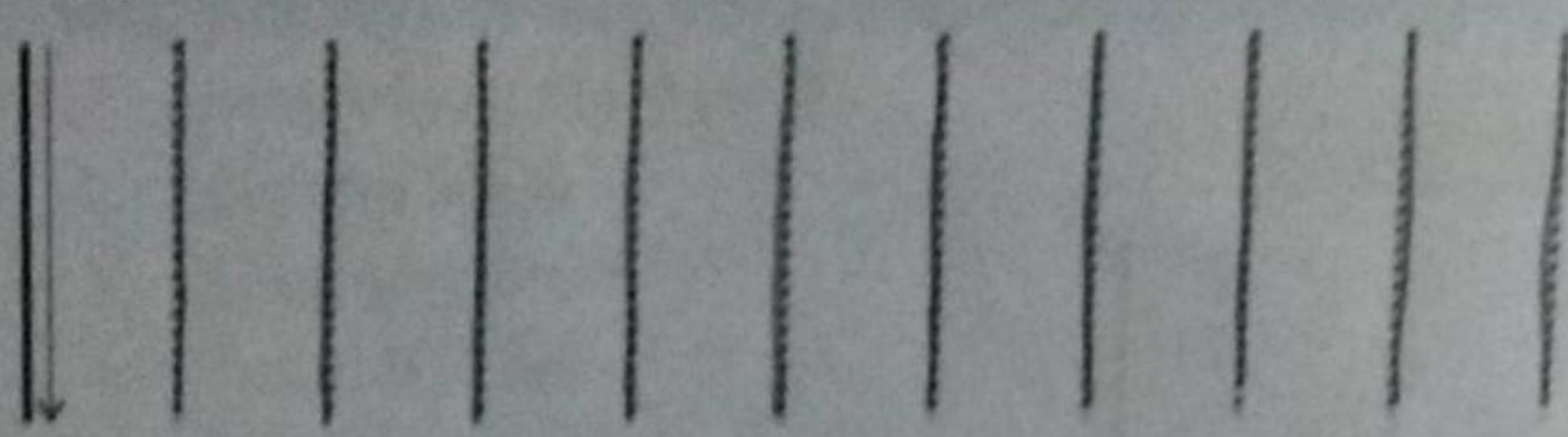

Draw sleeping lines:

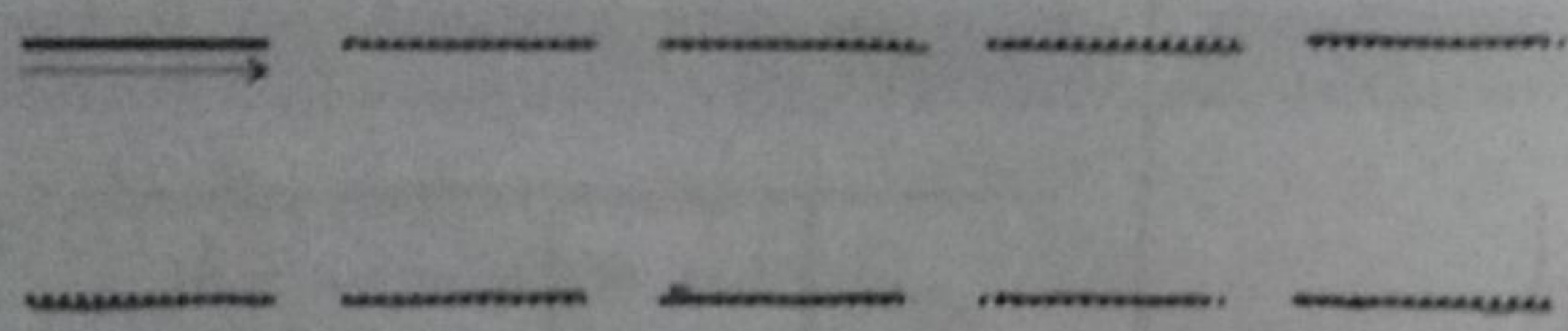

Draw both the above lines:

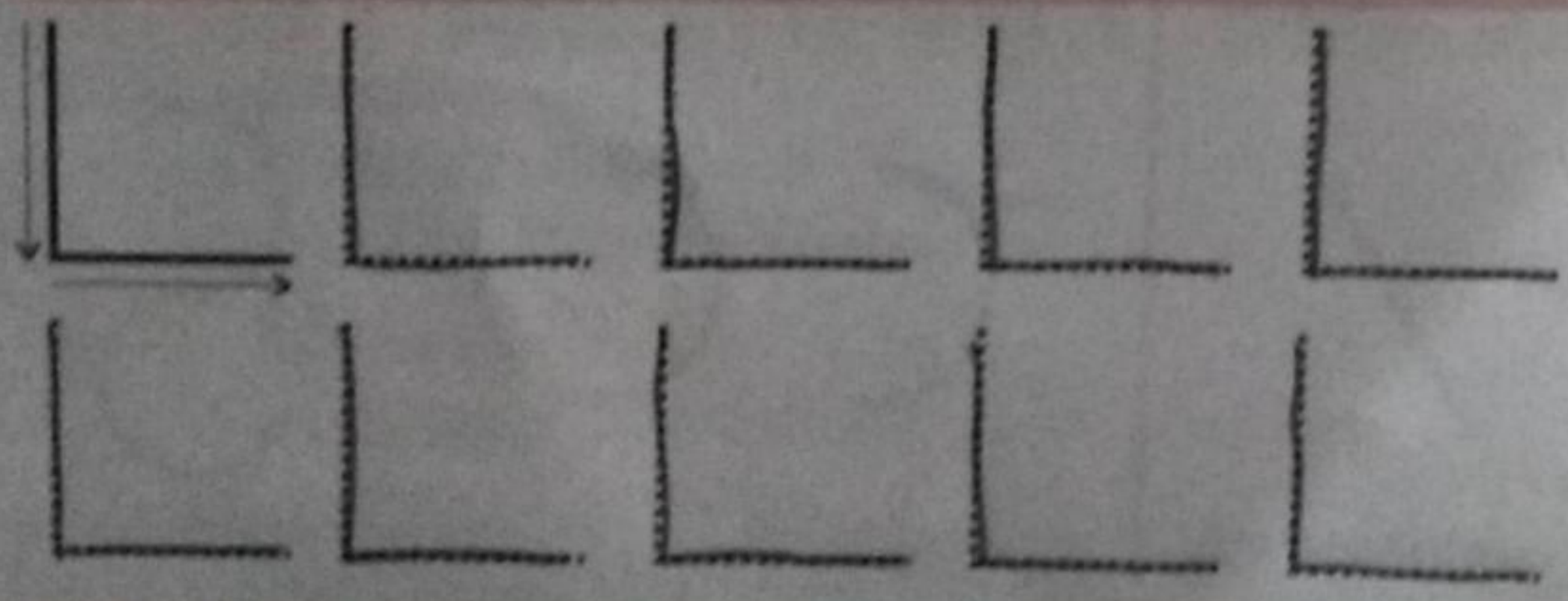

Draw lines for the ladder:

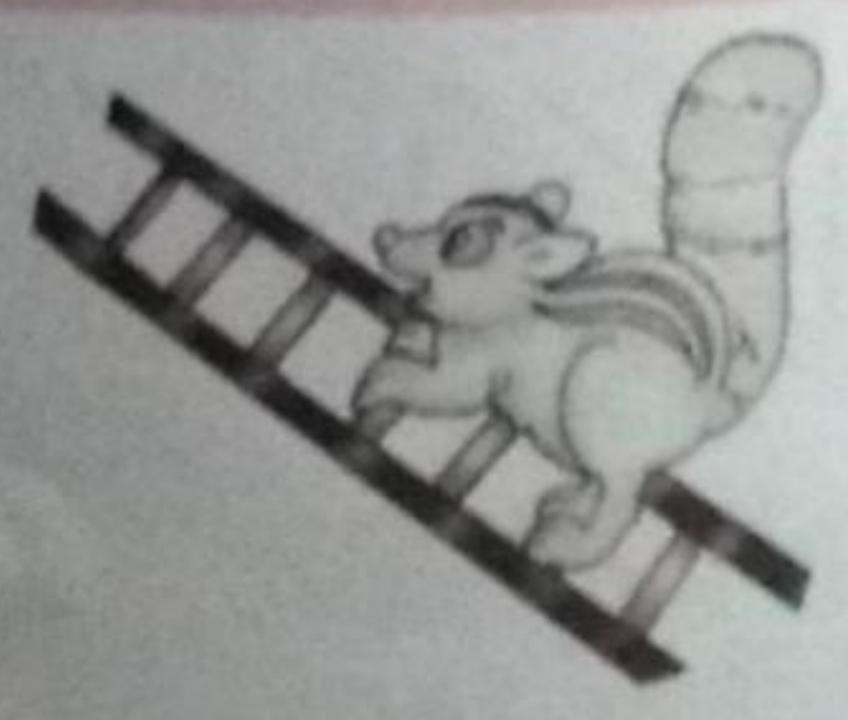
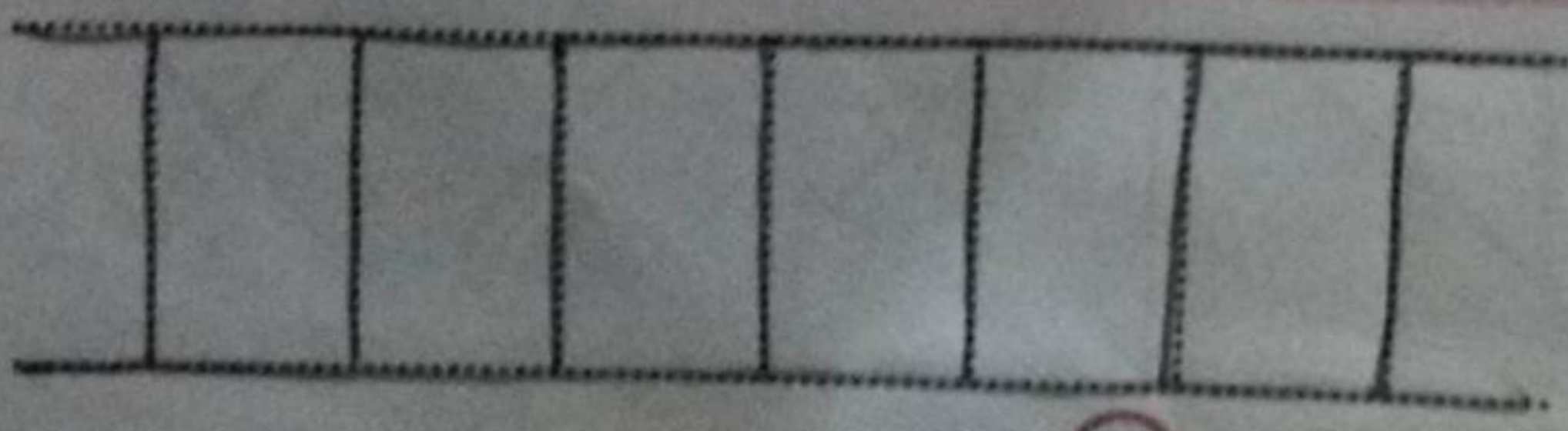

Draw slanting lines:

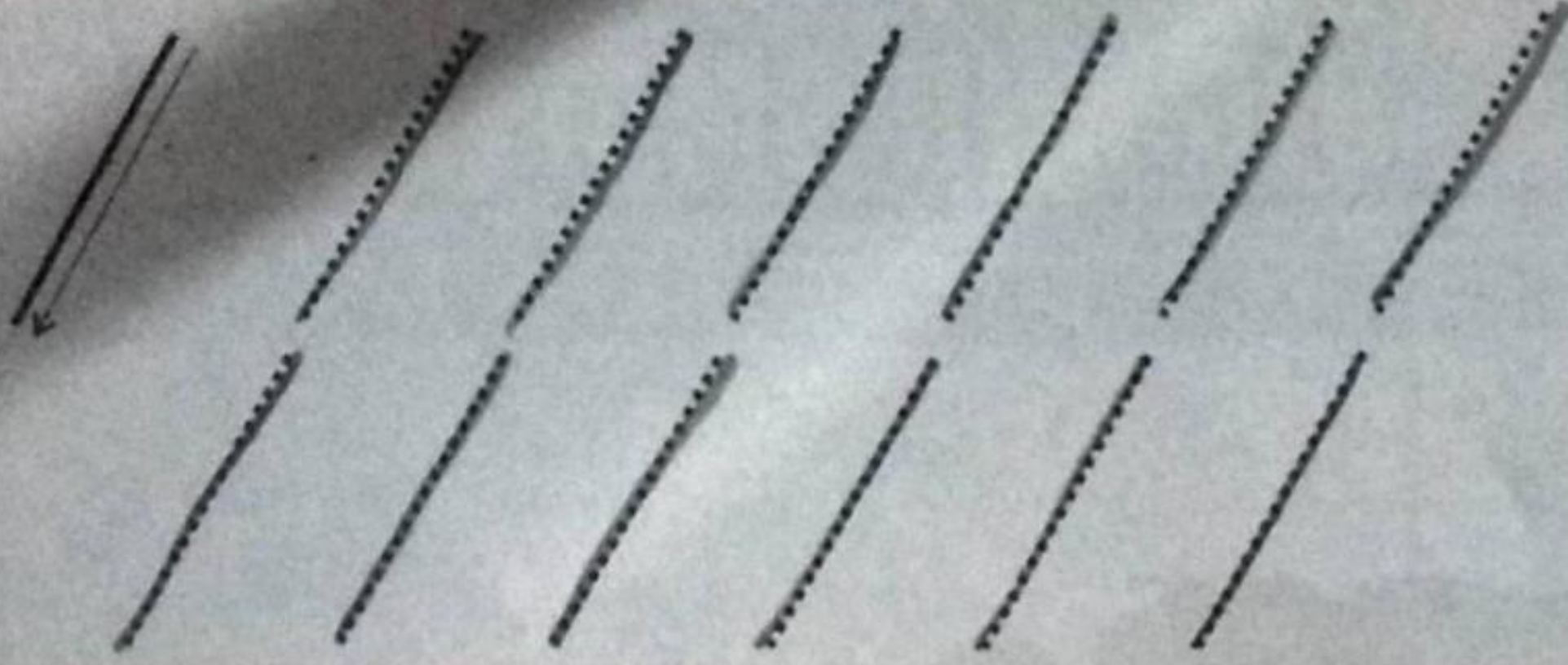

Draw tick marks:

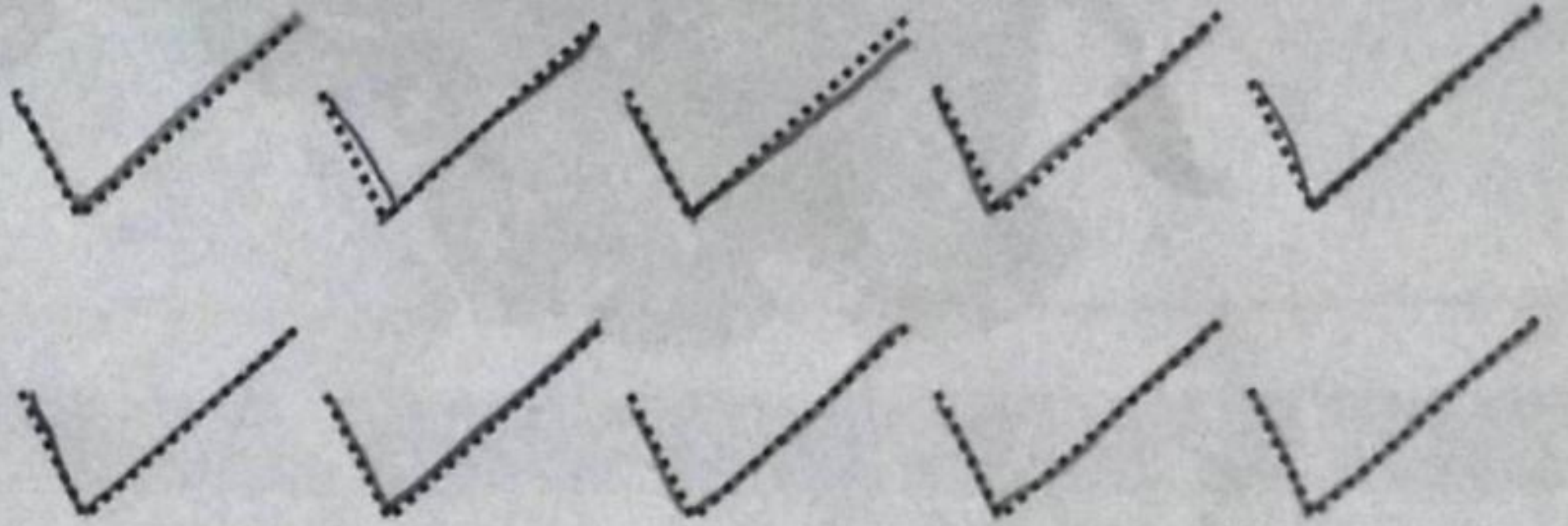

Draw cross marks:

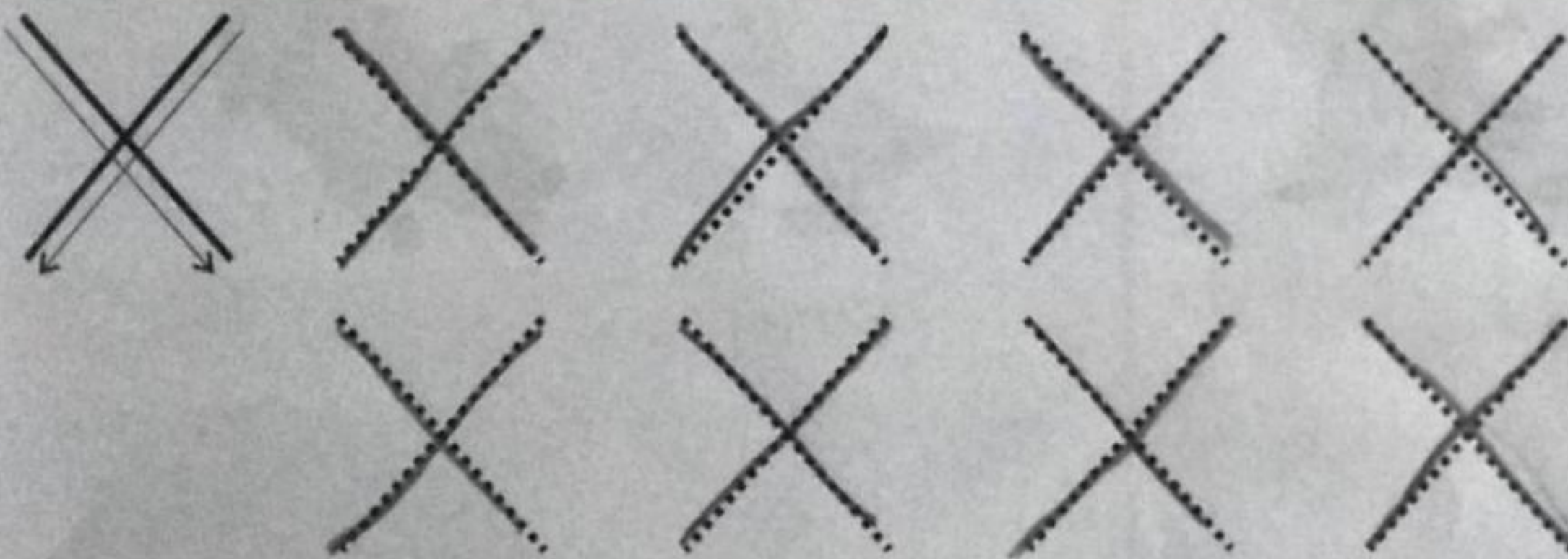

Draw curved lines:

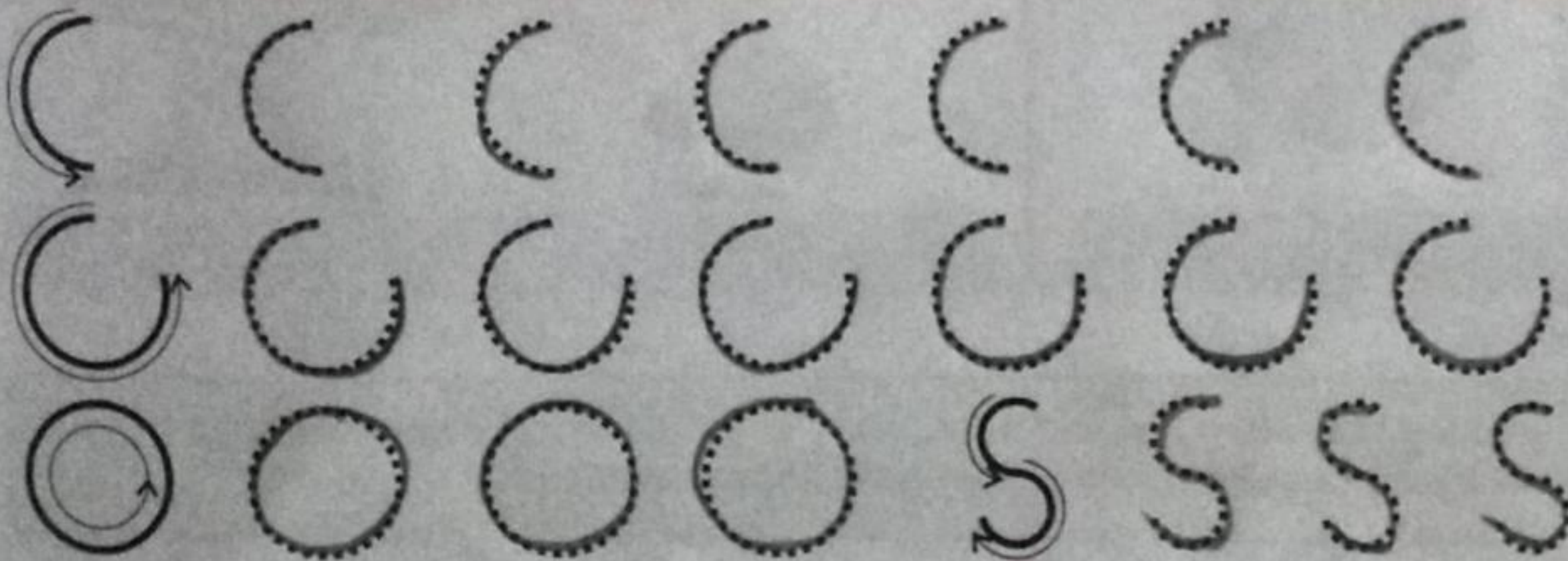

# Practice Time

Colour the bigger objects Red.

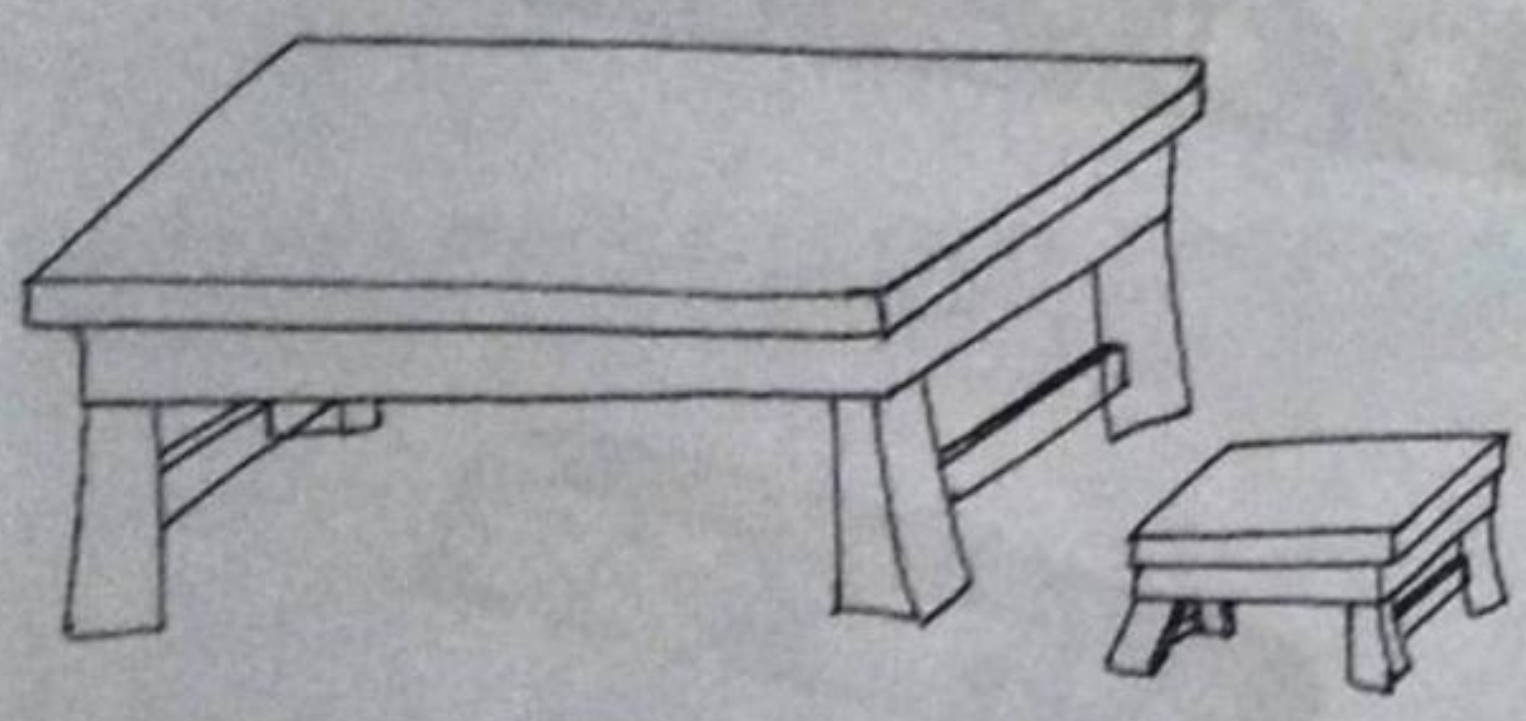
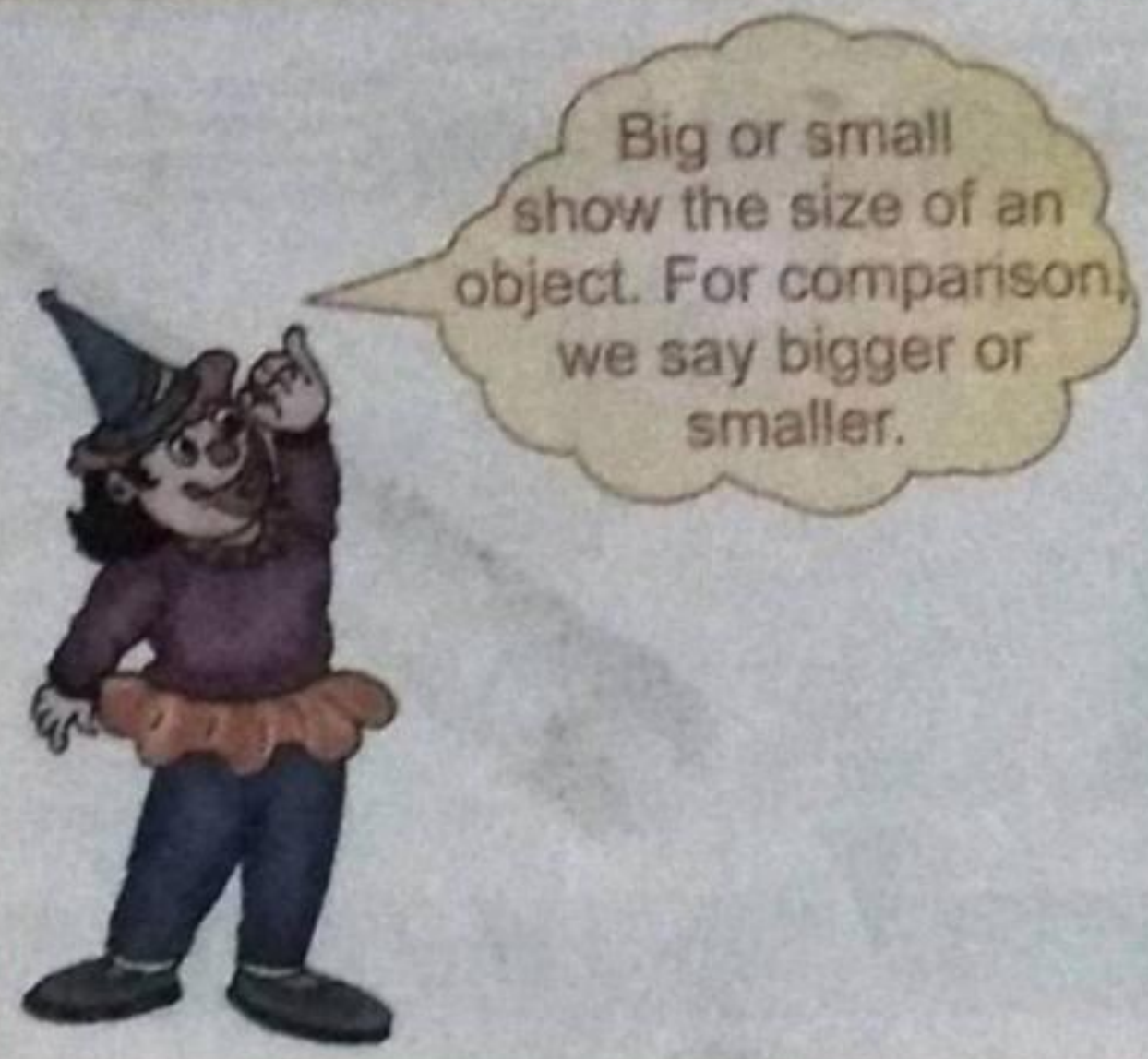

Colour the smaller objects green.

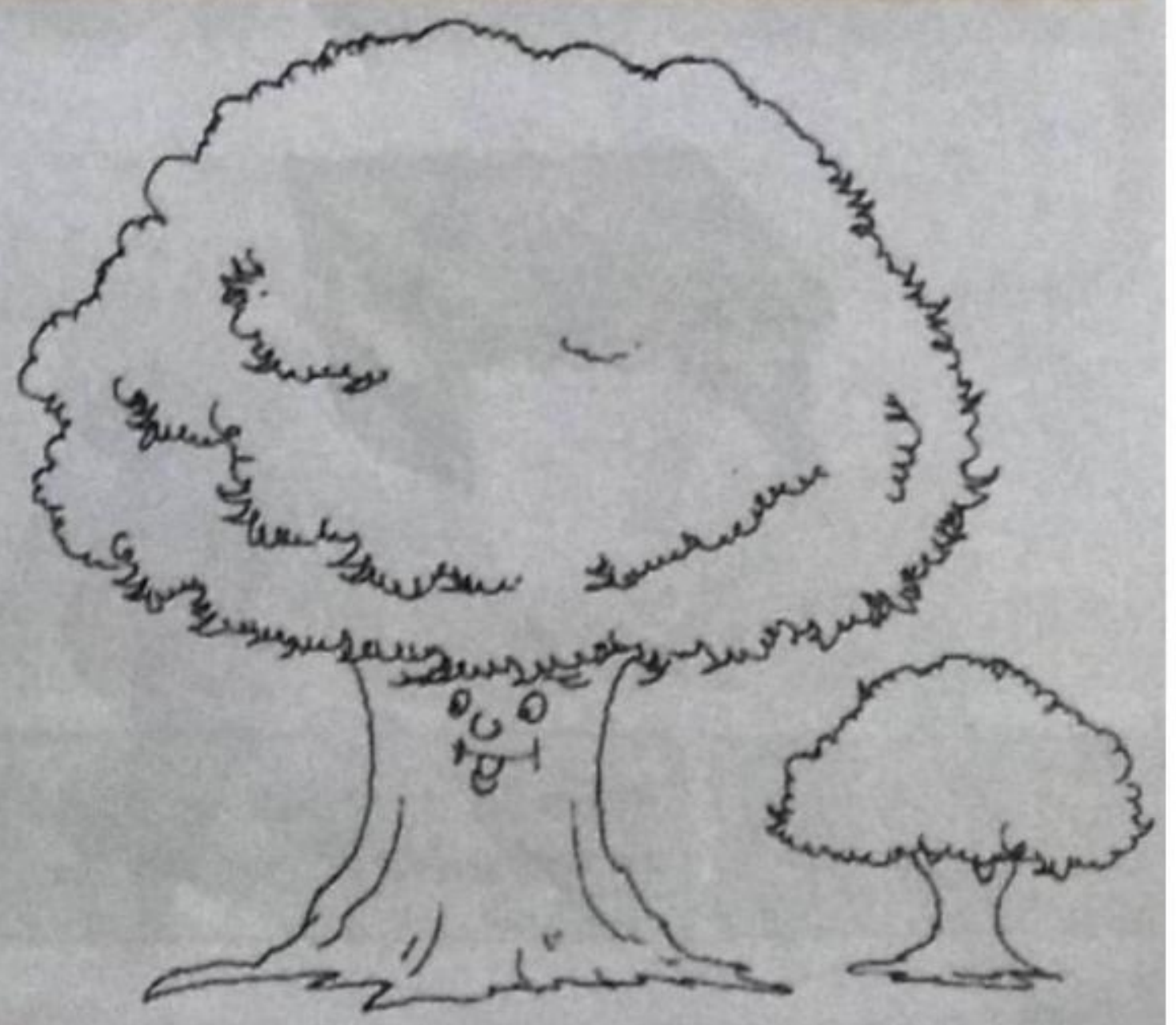
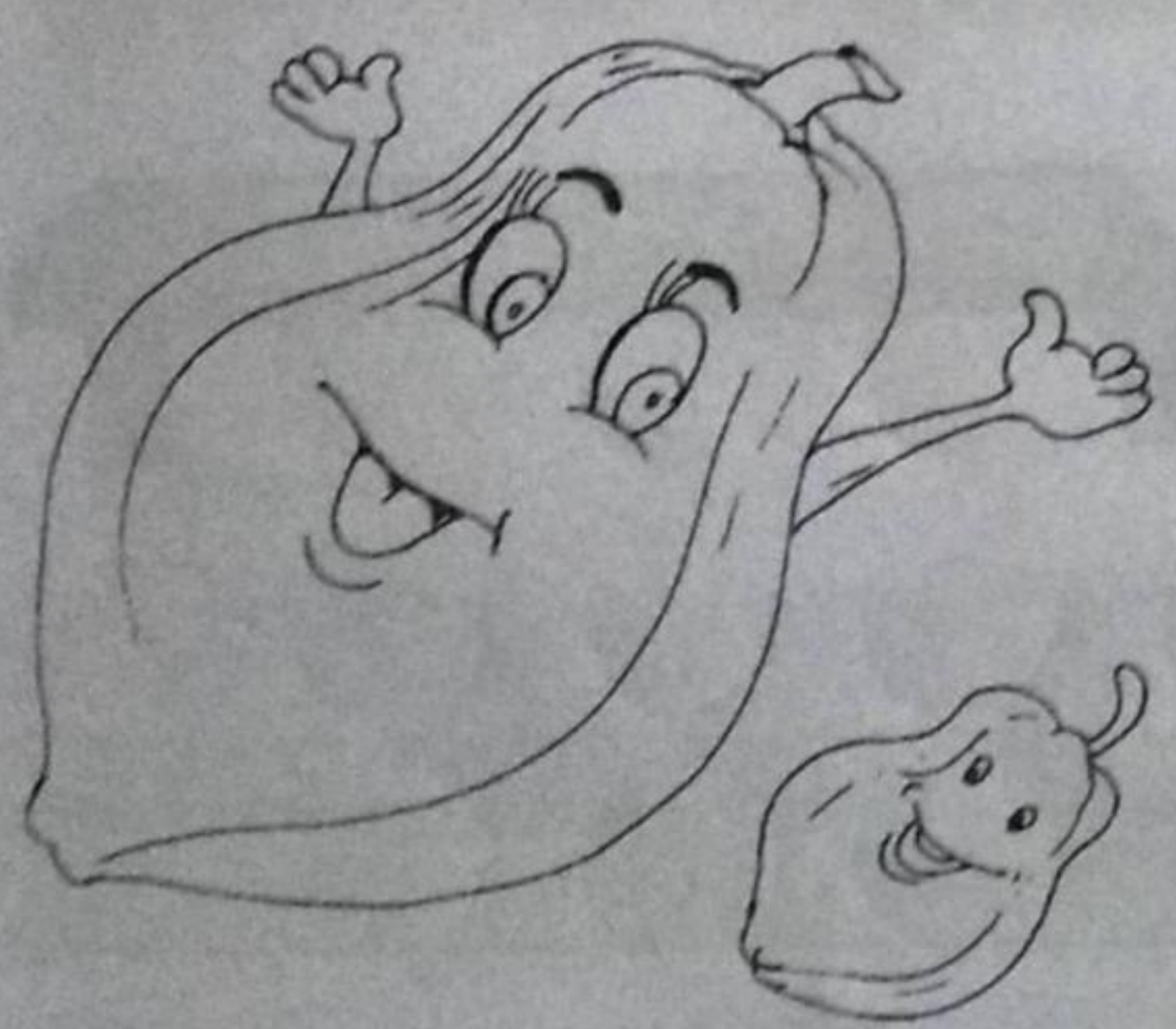

# Practice Time



Tick (✓) the longer objects.

Two cricket bats are shown. The left bat is significantly longer than the right bat. Below each bat is a rectangular box for marking.

Two snakes are shown. The snake on the left is short, while the snake on the right is long and winding. Below each snake is a rectangular box for marking.

Two leaves are shown. The left leaf is large and broad, while the right leaf is small and narrow. Below each leaf is a rectangular box for marking.

Two toothbrushes are shown. The left toothbrush has a long handle, while the right one has a short handle. Below each toothbrush is a rectangular box for marking.

Cross (×) the shorter objects.

Two umbrellas are shown. The left umbrella is large and open, while the right one is small and closed. Below each umbrella is a rectangular box for marking.

A long nail and a small dot are shown. Below each is a rectangular box for marking.

Two sofas are shown. The left sofa is large and brown, while the right one is small and pink. Below each sofa is a rectangular box for marking.

Two dresses are shown. The left dress is blue and long, while the right one is green and shorter. Below each dress is a rectangular box for marking.

Practice Time

Tick (✓) the taller objects.



Cross (×) the shorter objects.

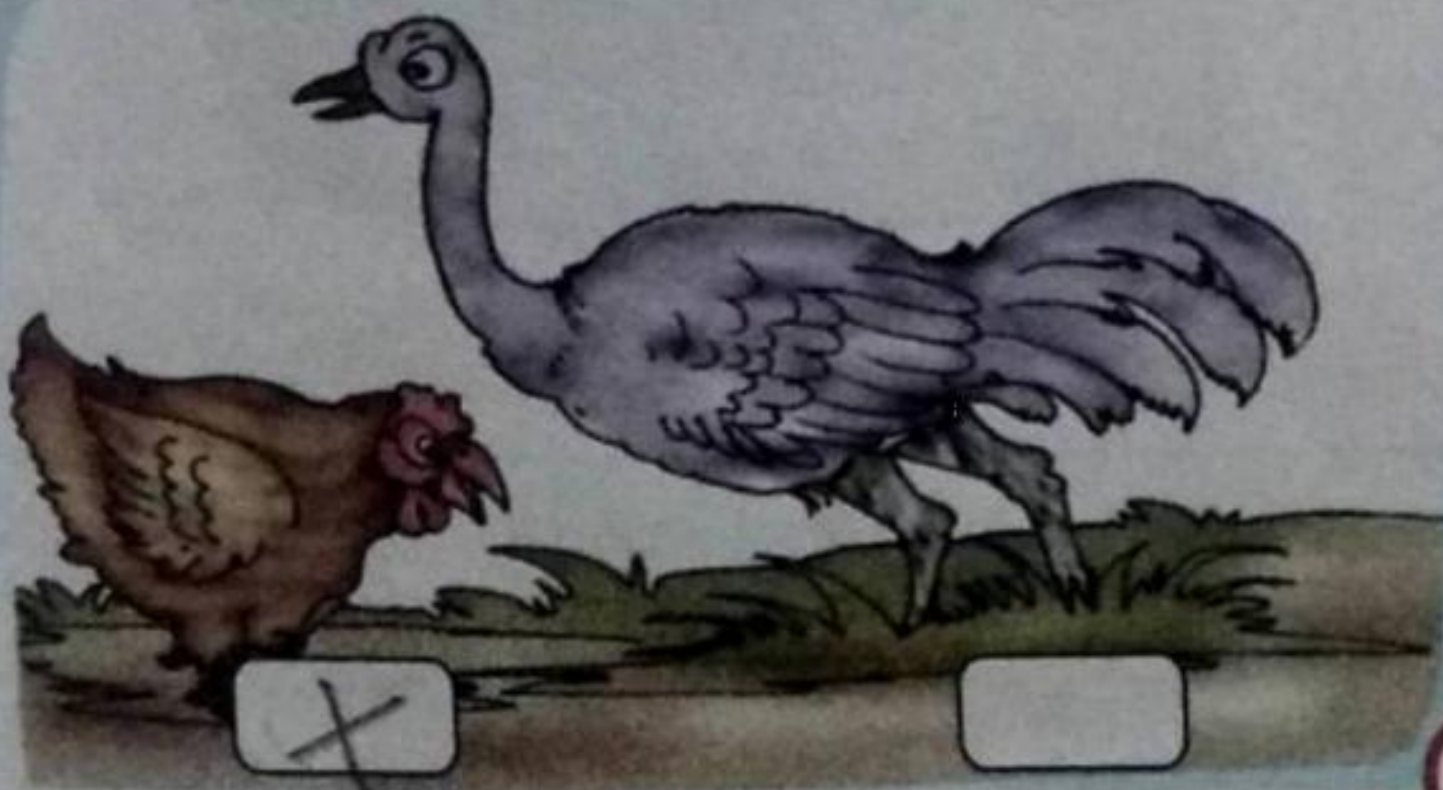



# Practice Time



Tick (✓) the thicker objects.

Cross (×) the thinner objects.

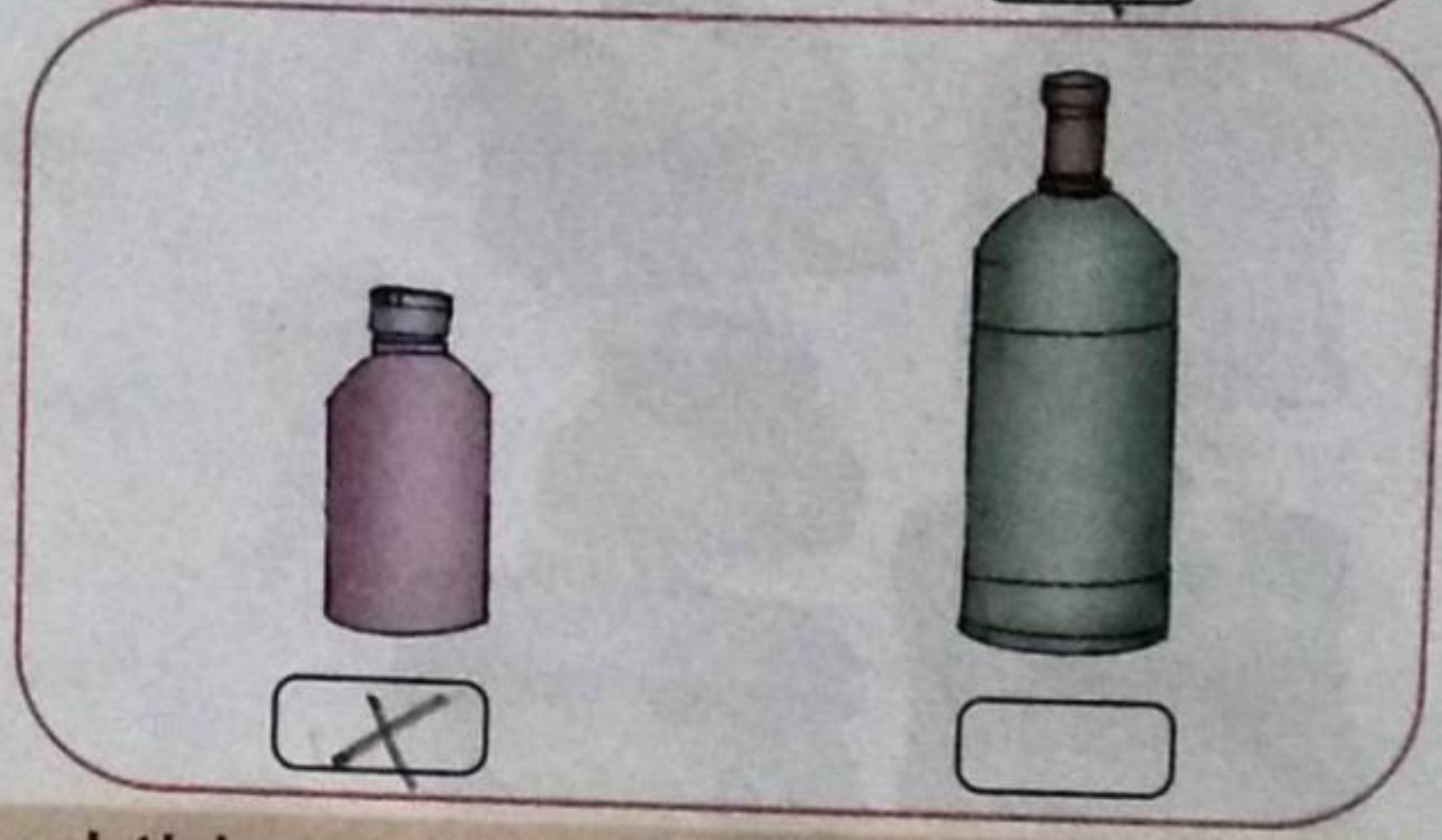
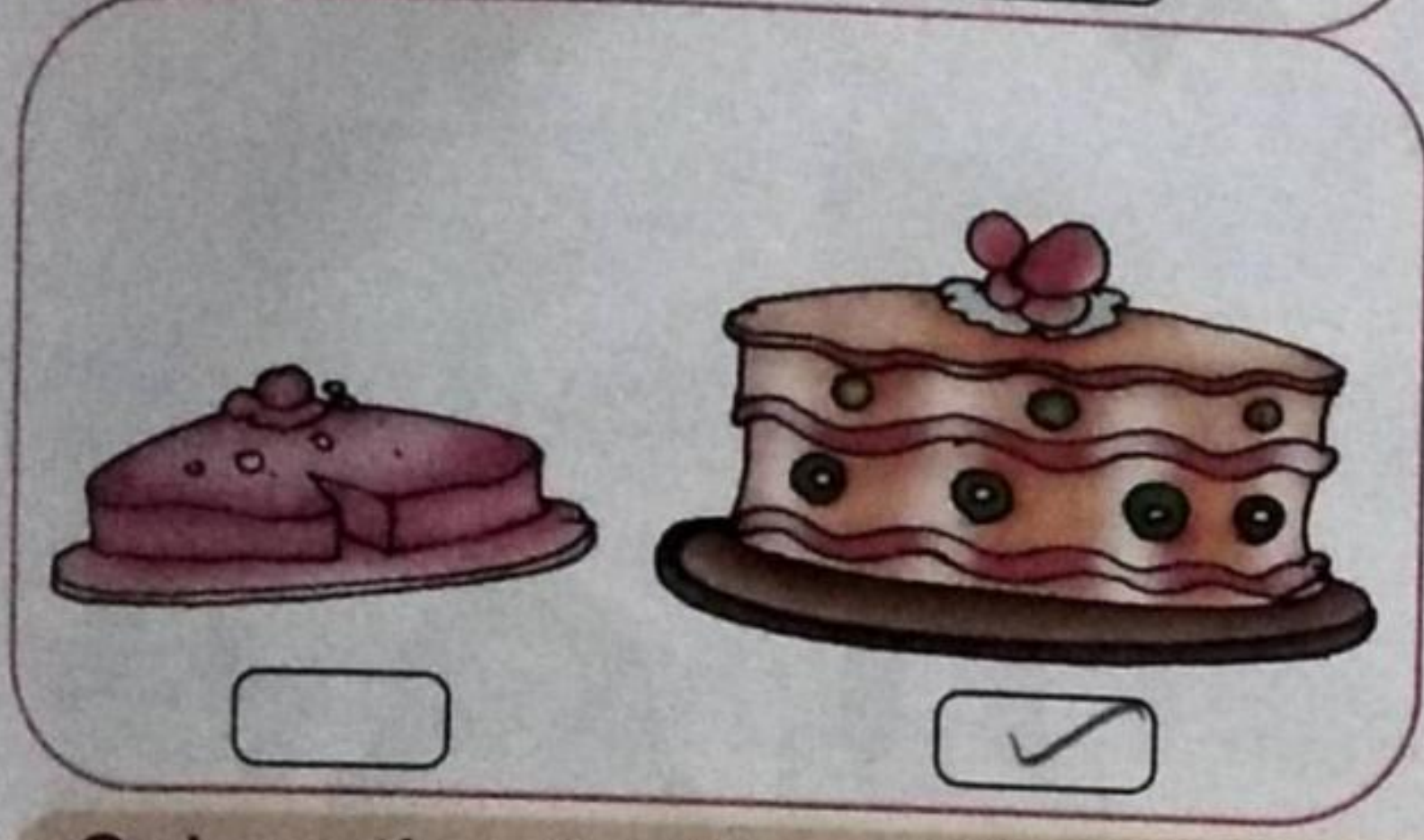
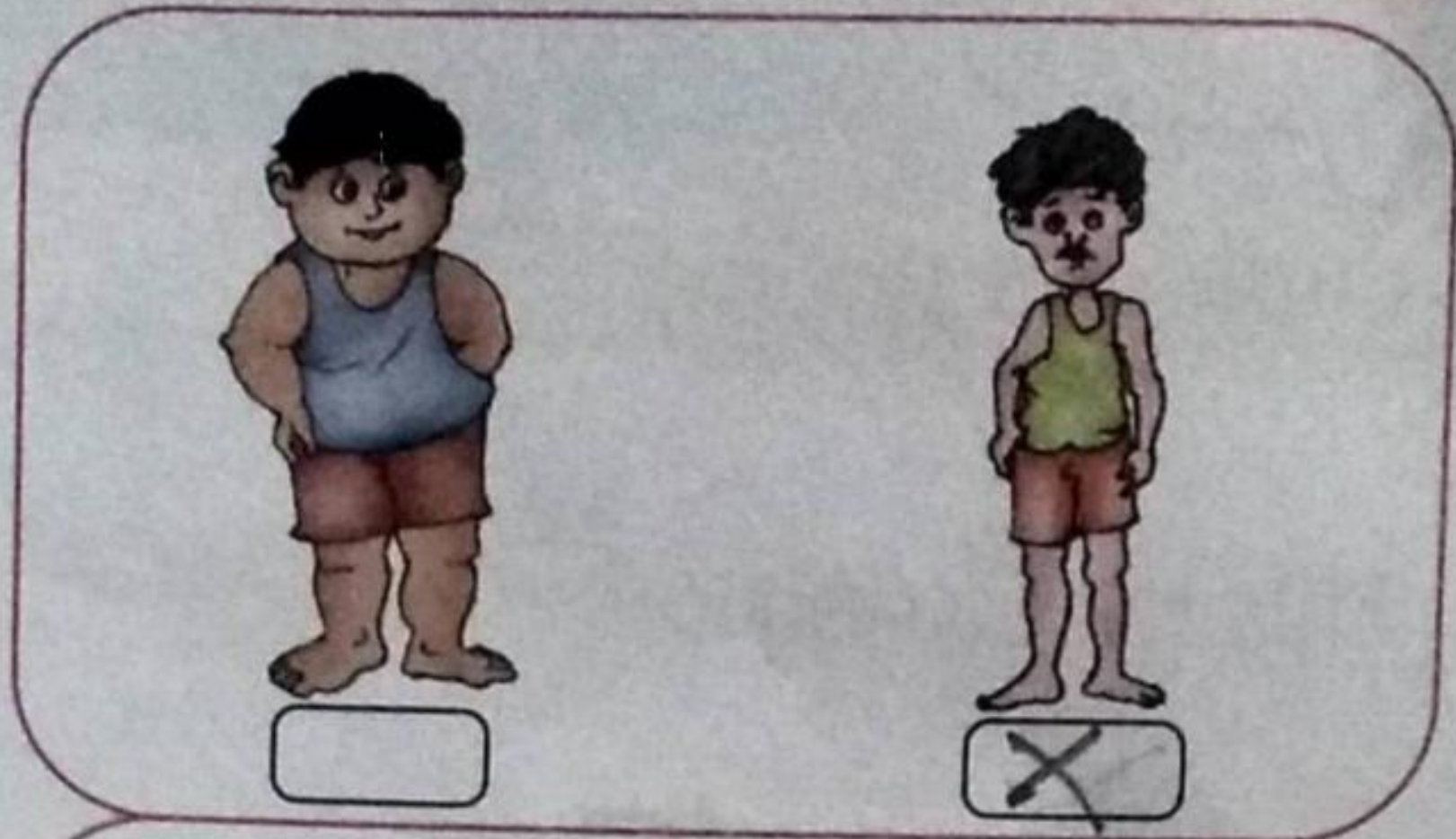
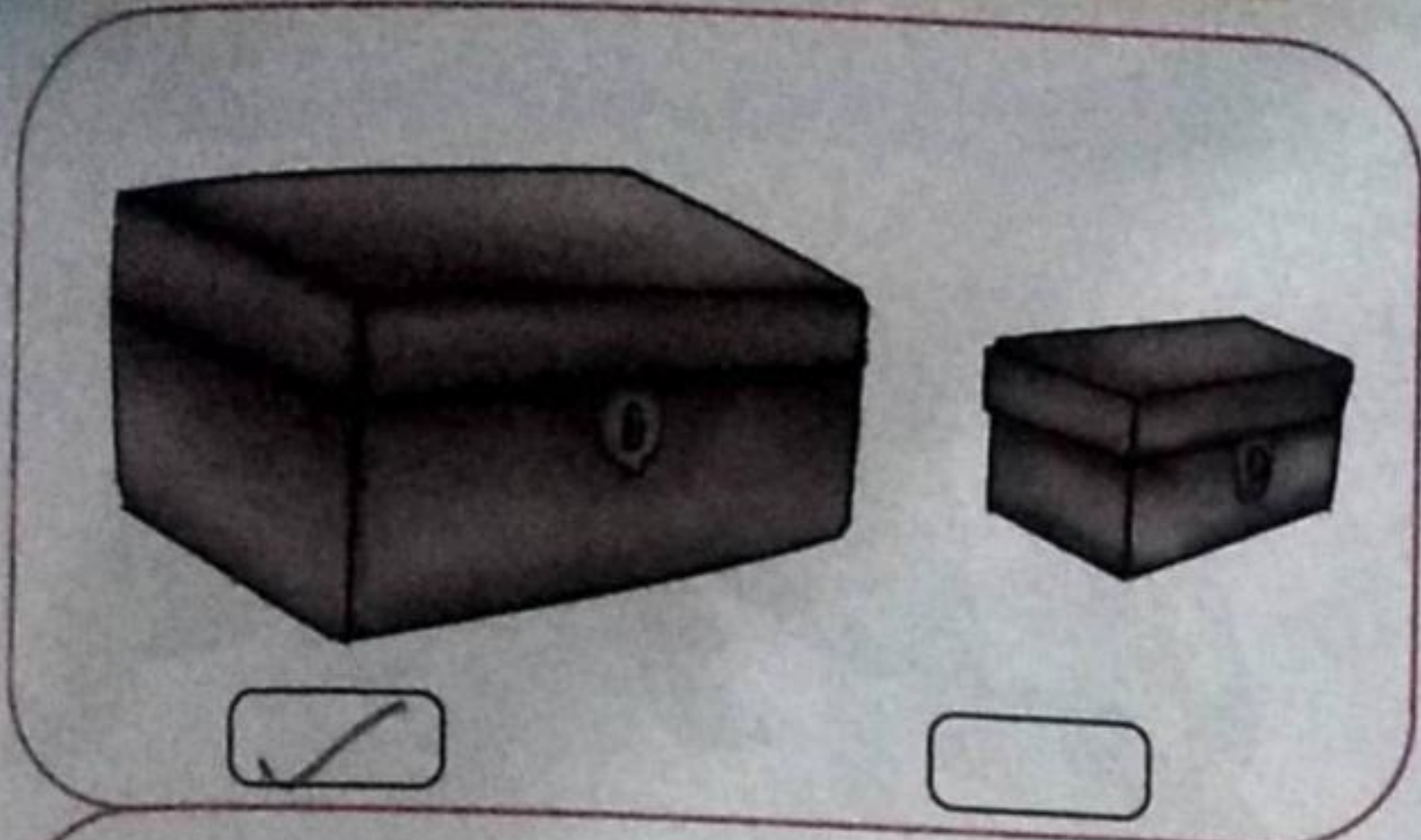

Colour the thicker object green and thinner object red.

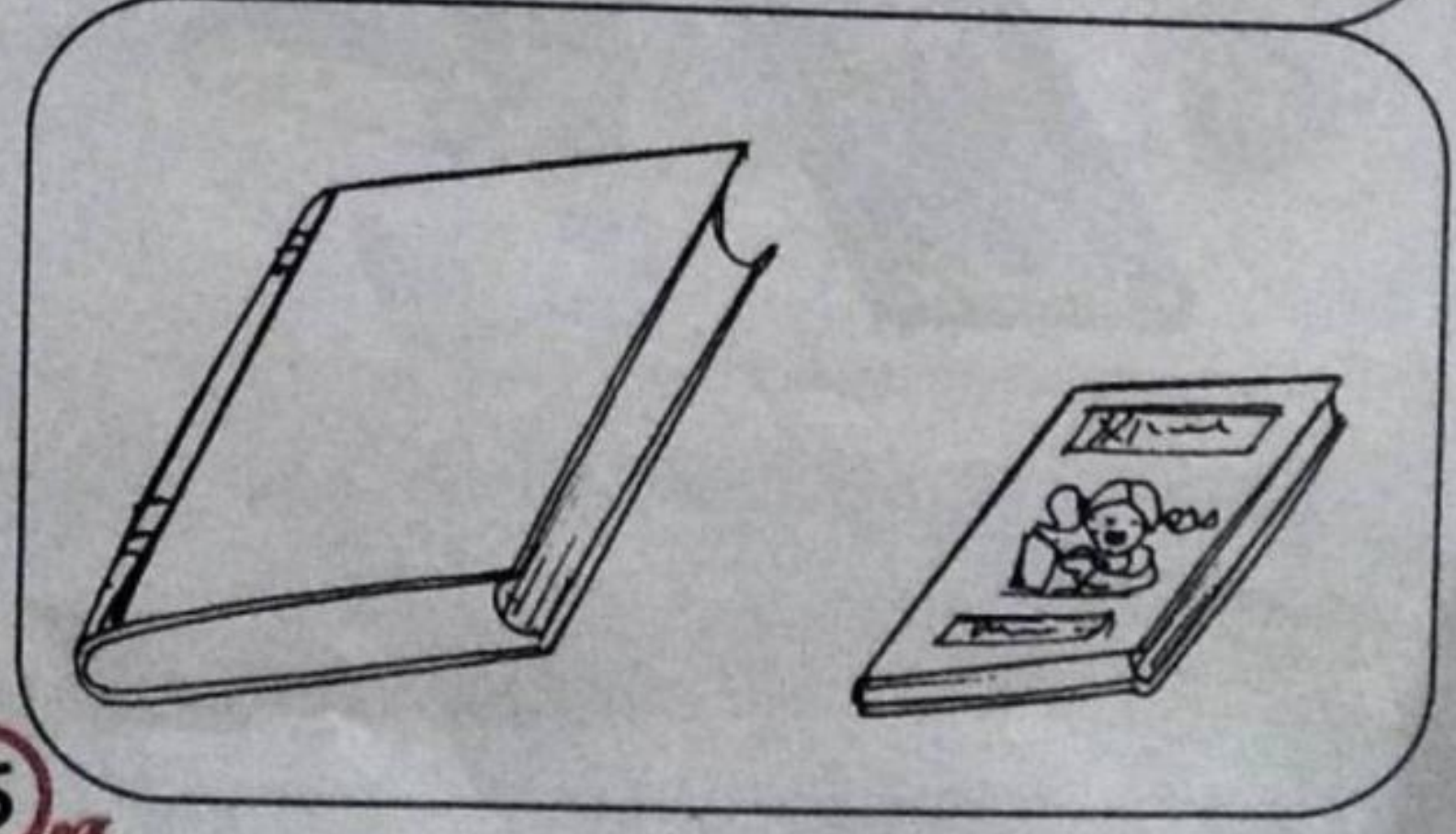
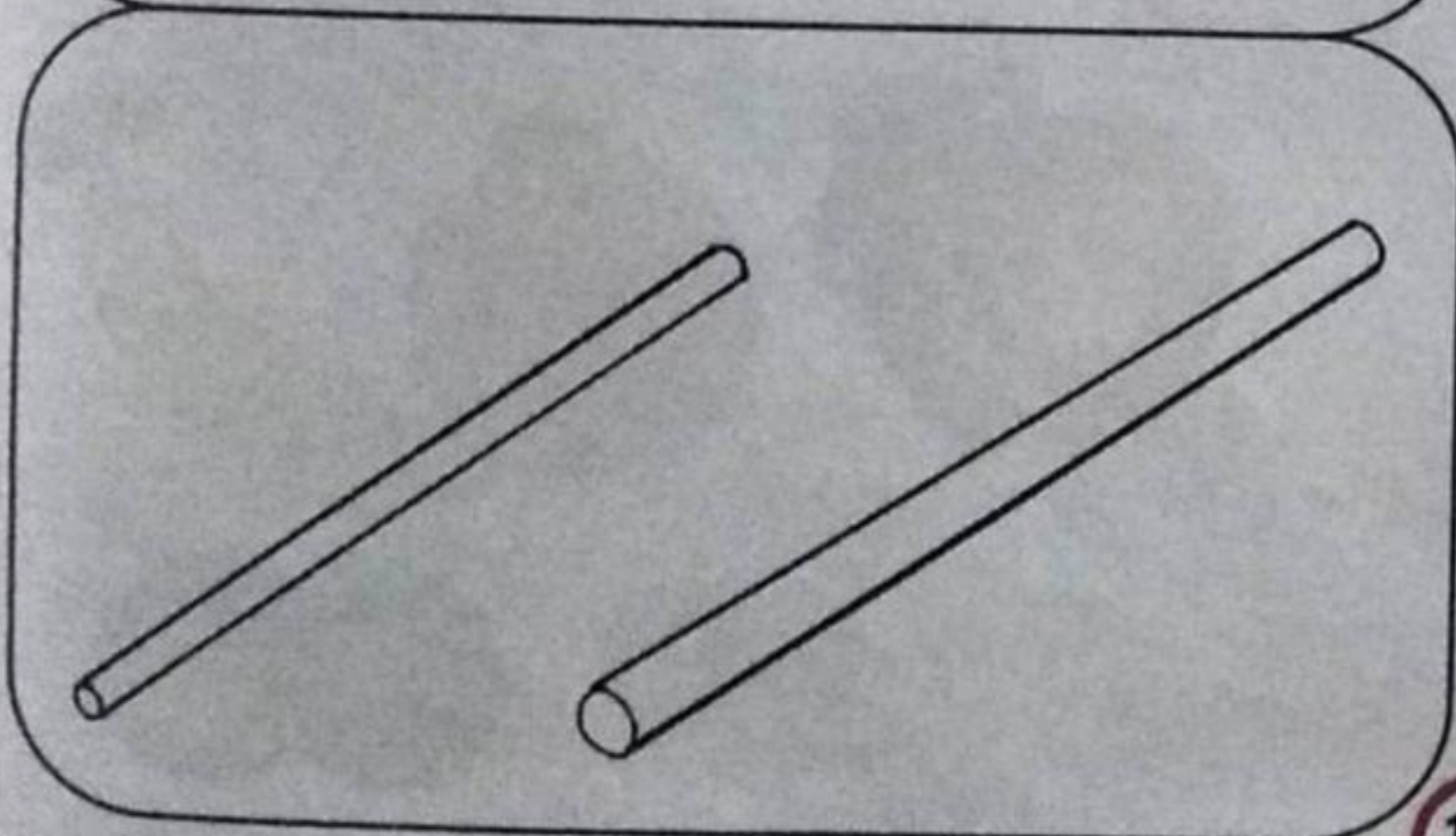
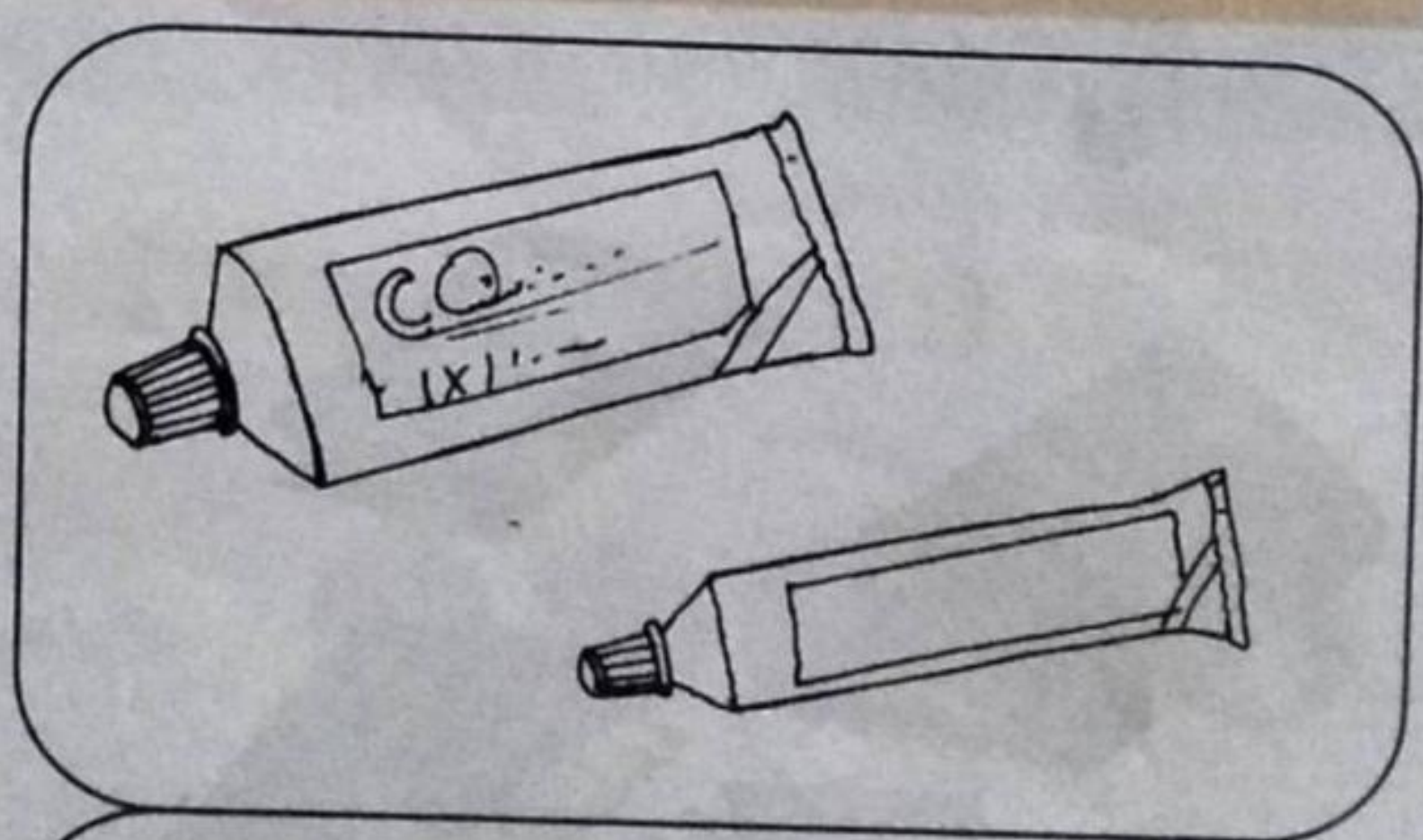
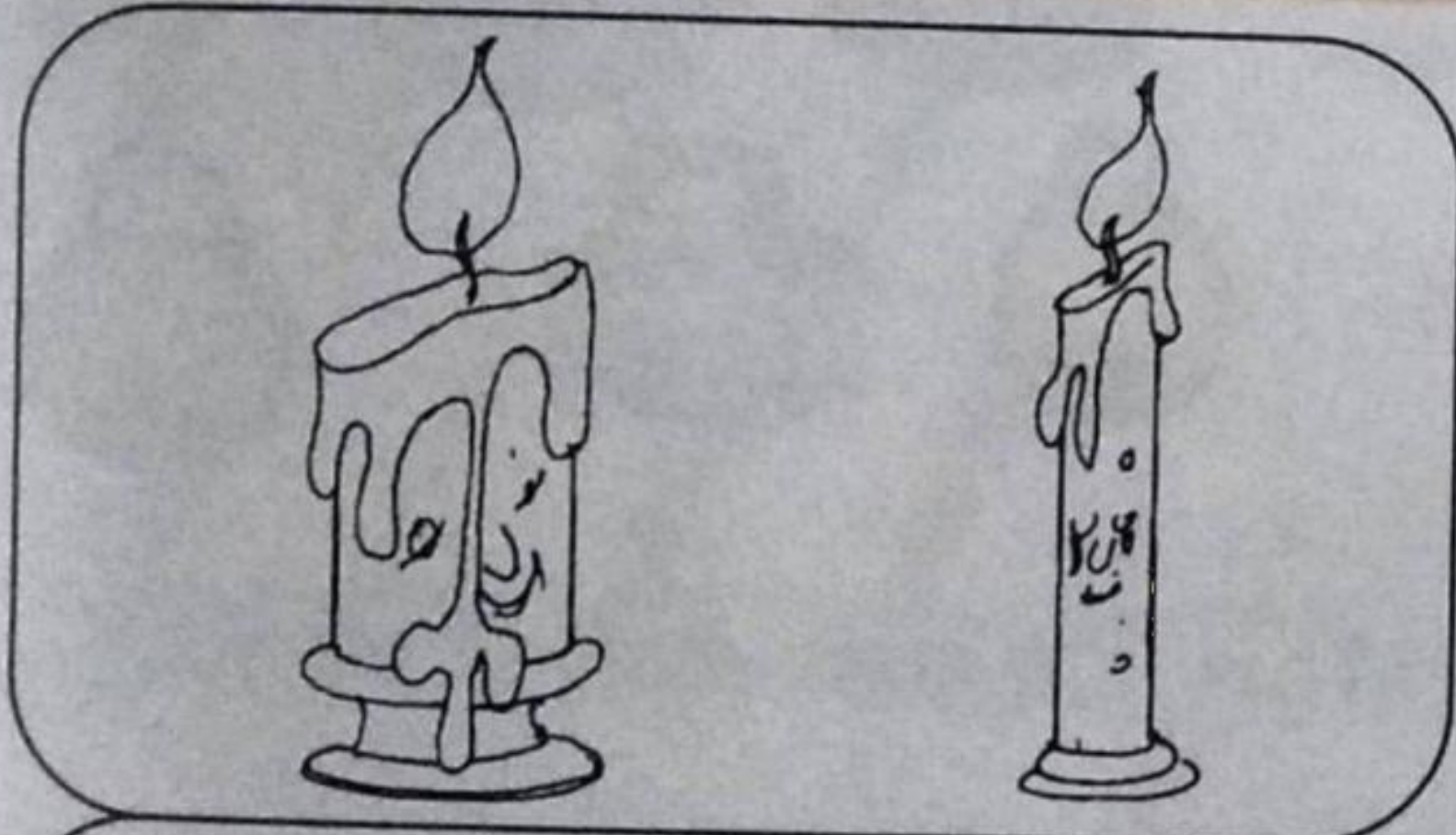

# Practice Time

Fill in the blanks.

This is a collection of FLOWERS →



← This is a collection of MUGS...



This is a collection of TOYS →



← This is a collection of PENS.

This is a collection of BALLS →



**Note for the Teacher**

This lesson is only for *oral practice*. You should first read out the 'Name of the collection' aloud and then make the children repeat it after you. Having done this repeatedly for several times, you should encourage the children to name the collections independently.